

# VACUUM PUMP SALES, SERVICE & SUPPLIES



**MADE IN  
USA**



TMSRV630

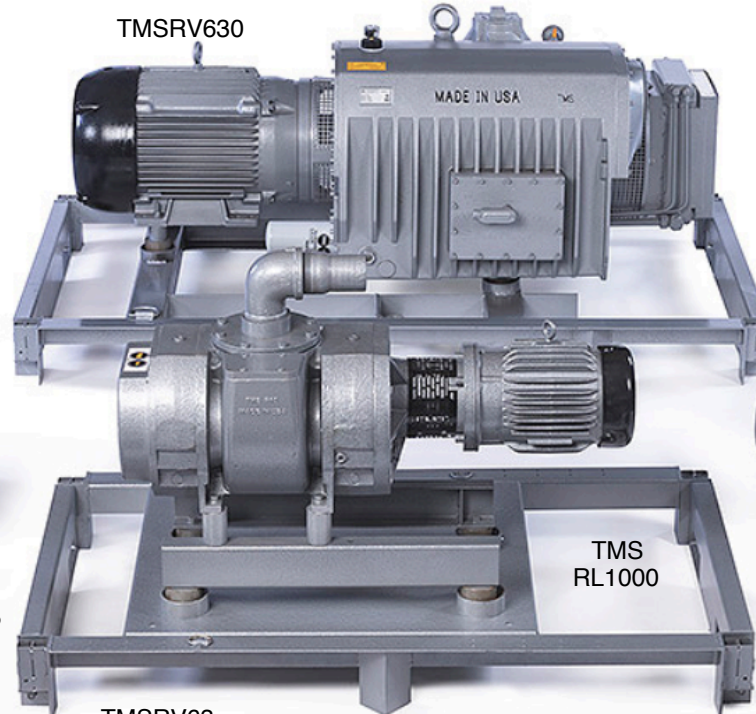

TMS  
RL1000

TMSRV165



TMSRV205



TMSRV305

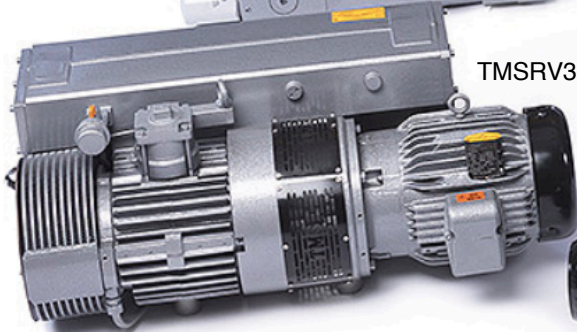

TMSRV63

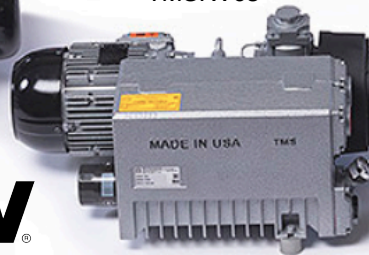

TMSRV100

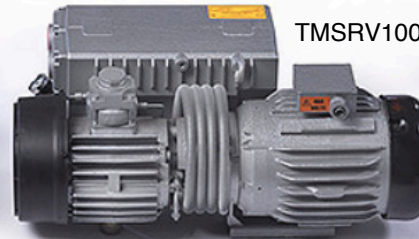

TMSRV255

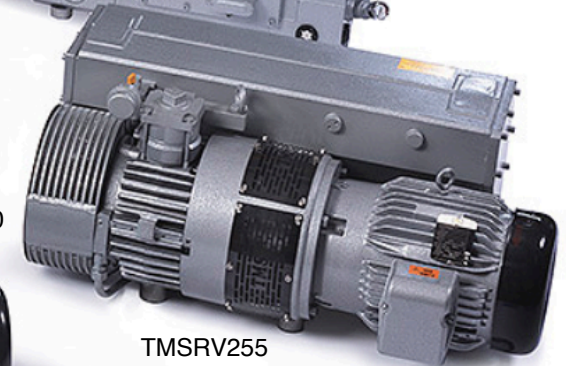

**MOTION**

## TOTAL MAINTENANCE SOLUTIONS (TMS) CAPABILITIES

JANUARY 2021

## TMS Core Values

- Craftsmanship
- Customer Service
- Fast Service
- Problem solving
- Real-Time
- Customer First
- Growth Oriented
- Family Oriented
- All team members rely on each other to make customer happy

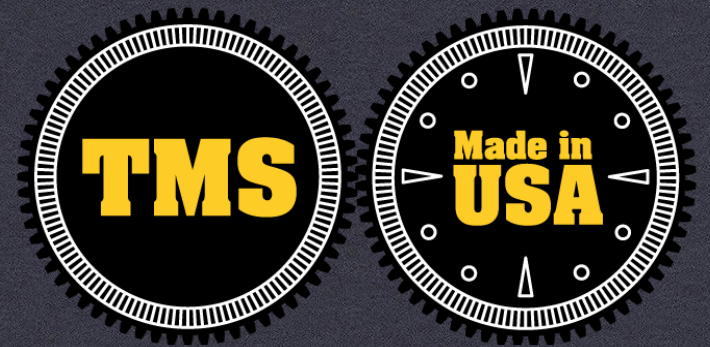

# TMS Core Focus

- **Passion =**  
Disrupt Busch  
with Super Loyal  
TMS Customers
- **Niche =**  
Reliable Vacuum  
Solutions

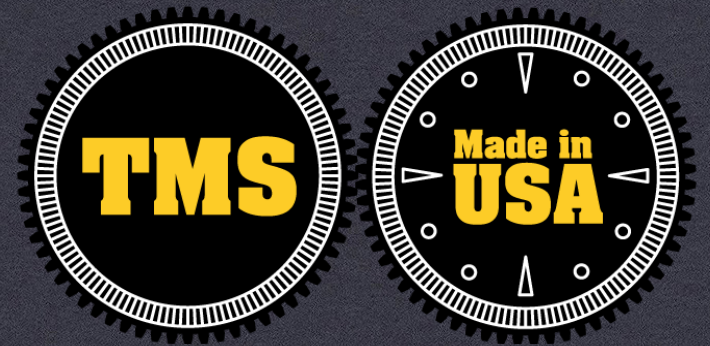

# Three TMS Uniques

1. Super Fast  
Delivery<sup>2.</sup>
2. Single Source  
Vacuum Supplier
3. Industry Insider  
Driven  
Innovations



## TMS Proven Processes:

- High-Touch Inbound Service
- Team Wide CRM Documentation
- PO to Packing Slip Tracking
- Tear Down & Repair Transparency



# TMS Guarantees:

All TMS Pumps Made in USA

- All TMS Pumps Made in USA
- Orders by 2pm CST Ship Same Day
- All Pumps - New & Rebuilds  
- Hot Tested  
to Pull Proper Torr

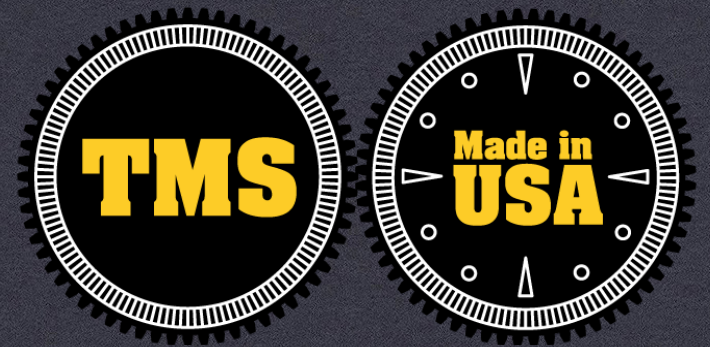

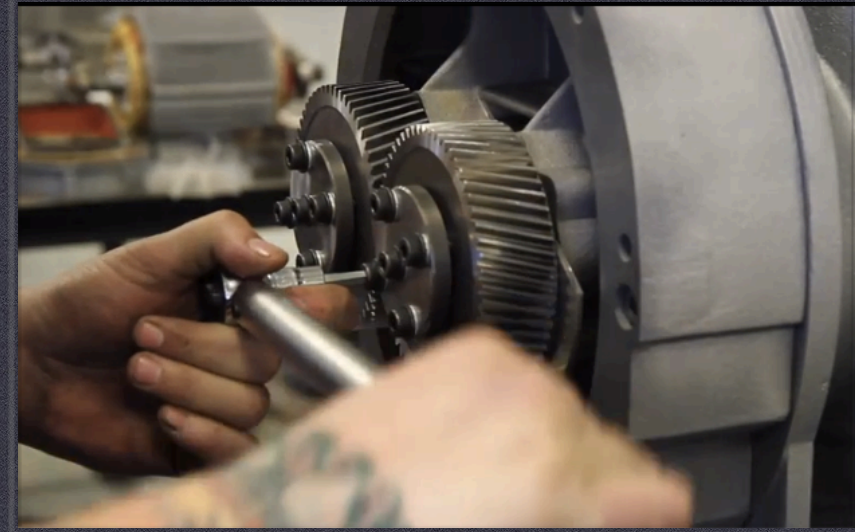
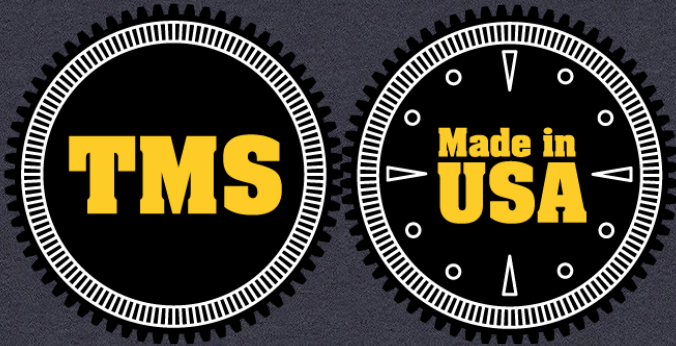

# SUMMARY

- MADE-IN-USA NEW VACUUM PUMPS & BLOWERS
- RECONDITIONED WARRANTIED VACUUM PUMPS & BLOWERS
- HOT TESTED VACUUM PUMP REPAIRS & REBUILDS
- EMERGENCY EXCHANGE PROGRAM
- BONEYARD TRADE-INS
- UPGRADED NEW VACUUM PUMP PARTS
- VACUUM PUMP OIL 30WT NON DETERGENT & FOOD GRADE
- VACUUM PUMP OIL & EXHAUST FILTERS
- ON-SITE VACUUM PUMP EVALUATIONS

***MOTION***



# LOCATION

- CENTRAL MIDWEST
- IL/IA QUAD CITIES
- ADJACENT TO INTERSTATES  
I-80, I-74, I-55
- 3407 78TH AVE WEST  
ROCK ISLAND, ILLINOIS

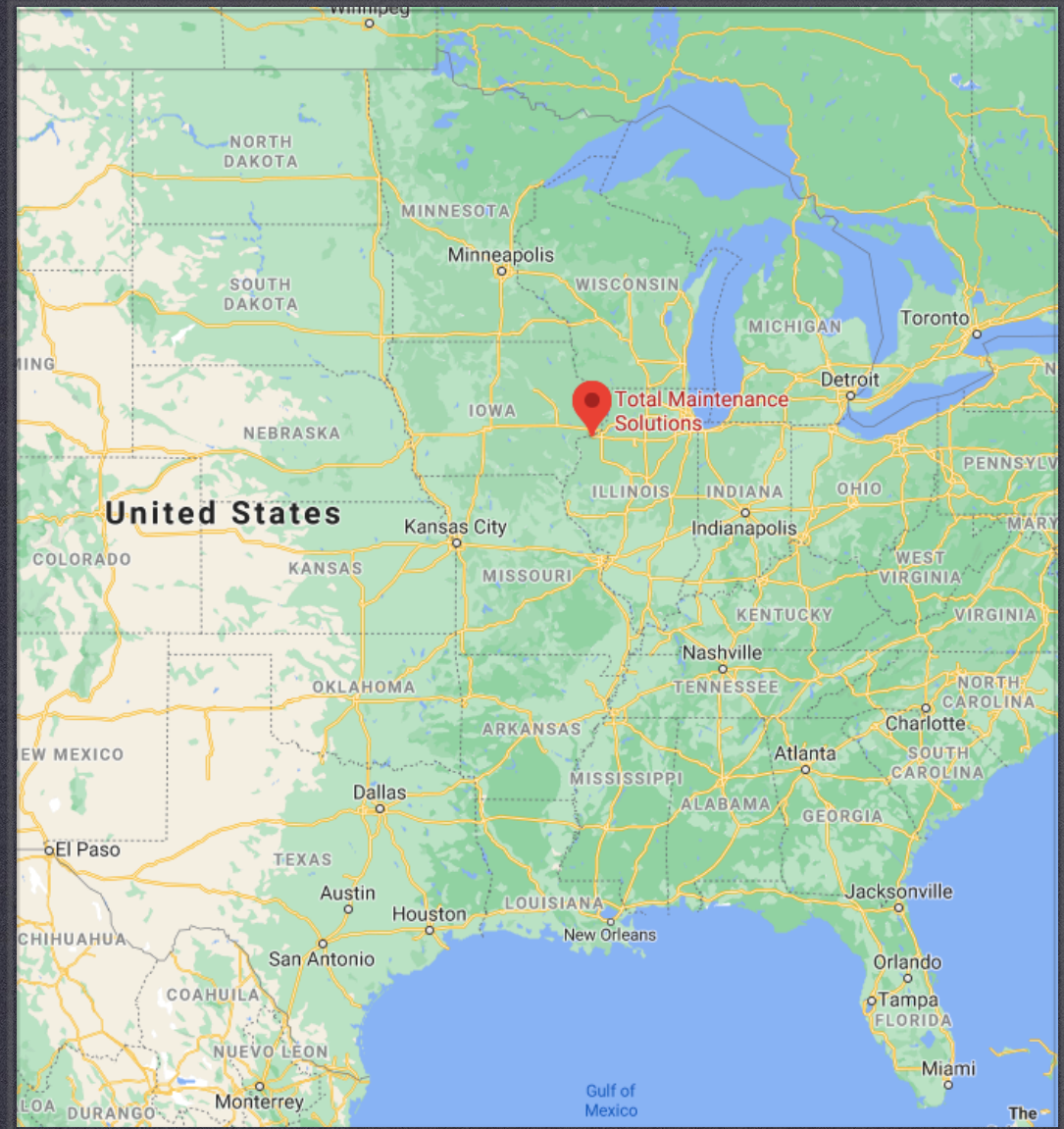





# FACILITY

- 26,000 SF
- SALES & SUPPORT
- PARTS & INVENTORY
- REPAIR & MANUFACTURING
- SANDBLASTING & PAINTING
- FABRICATION & MACHINING
- SHIPPING & RECEIVING

***MOTION***



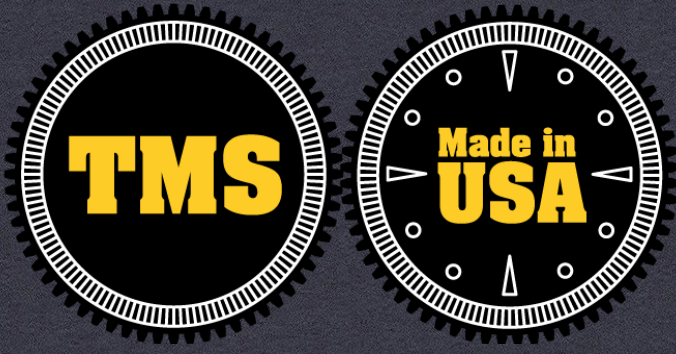

# TALENTED TEAM

- 5-STAR CUSTOMER SERVICE
- OVER 100 YEARS INDUSTRY EXPERTISE
- TRAVELING SALES & TECHNICAL SUPPORT



|   |  |   |
|---|--|---|
| <p><b>India Skinner</b><br/>Administrative Assistant, 2019-Present<br/>LinkedIn</p> | <p><b>Erica Lopez</b><br/>CSR, Office Admin, 2018 – Present<br/>LinkedIn</p> | <p><b>Matt White</b><br/>National Sales Manager, 2019-Present<br/>LinkedIn</p>                                    |
| <p><b>James Bickle</b><br/>Outside Sales, 2011-Present<br/>LinkedIn</p>             | <p><b>Mark "Goose" Gosney</b><br/>Sales Tech, 2014-Present<br/>LinkedIn</p>  | <p><b>Josh Ginglen</b><br/>Outside Sales, 2017-Present<br/>LinkedIn</p>   |
| <p><b>Cole Rieckenberg</b><br/>Account Manager, 2020-Present<br/>LinkedIn</p>       | <p><b>Rob Gilmore</b><br/>Parts Manager, 2005-Present<br/>LinkedIn</p>       | <p><b>Jeff Schmidt</b><br/>General Manager, 2015 – Present<br/>National Sales Manager, 2013-2015<br/>LinkedIn</p> |



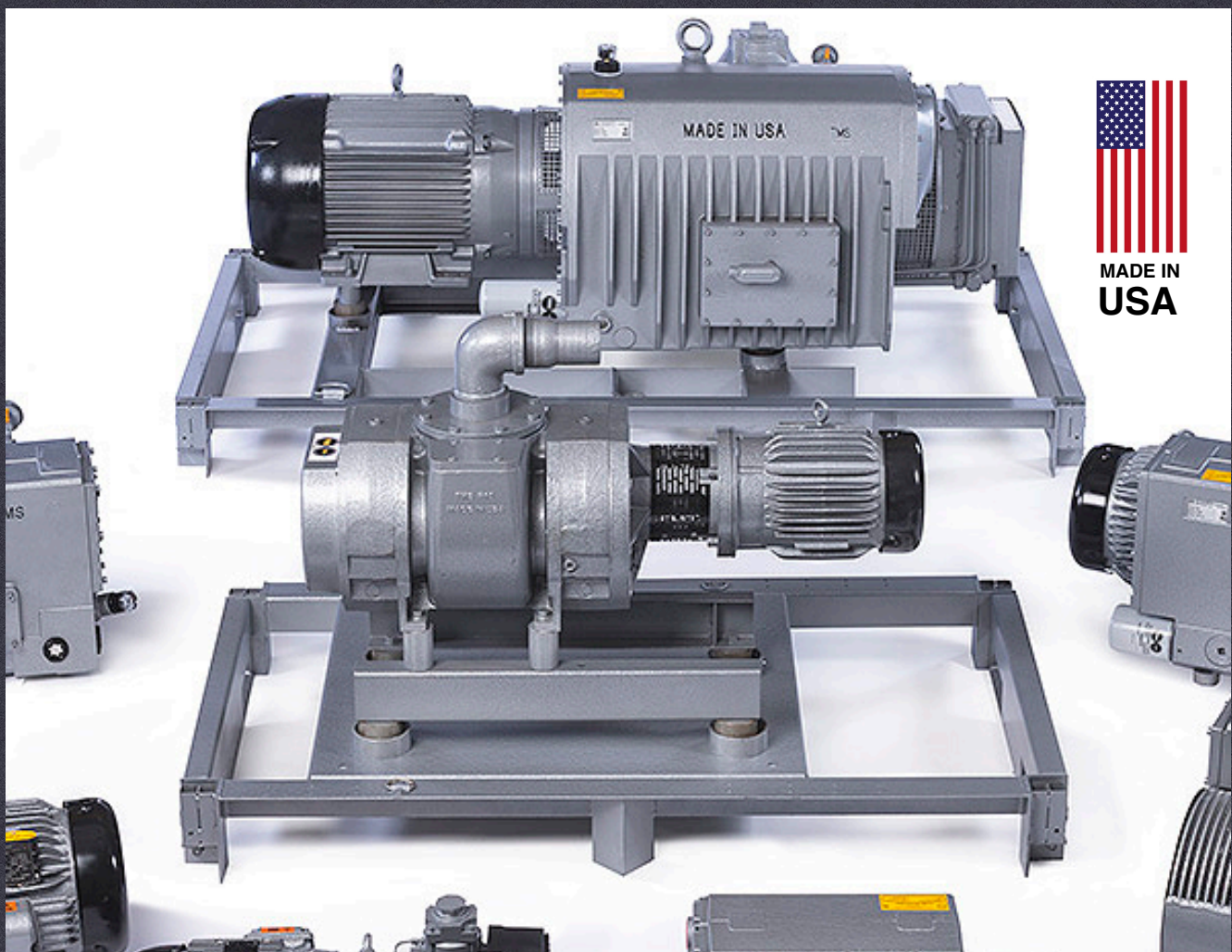

MADE IN  
USA

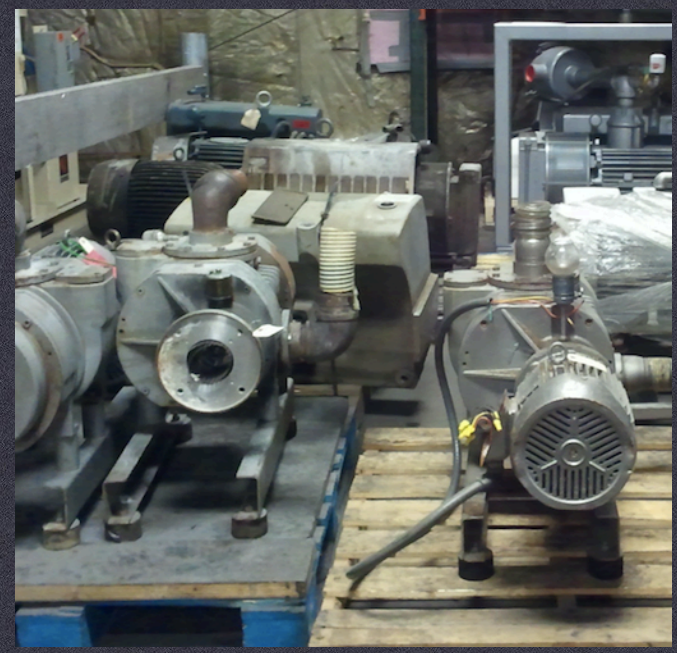

***MOTION***

**ROTATING EQUIPMENT: VACUUM PUMPS**



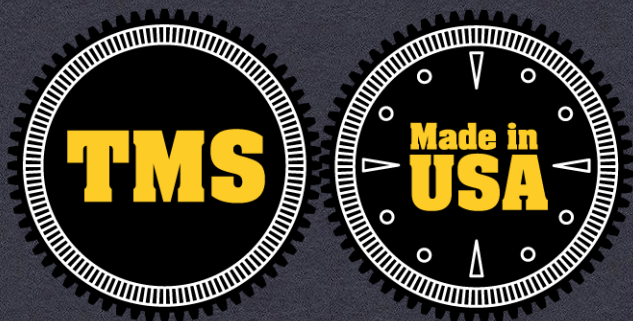

# FULL SPECTRUM VACUUM LINE

- ALL MADE-IN-USA
- SOLID STEEL USA PRODUCTS
- ALL SOURCED WITH SUPPLIERS W/IN 250 MILES
- 8 SIZES
- INDUSTRY LEADING INNOVATIONS
- COMPETITIVE LEAD TIMES
- SPEC'D & INSTALLED IN 3RD PARTY OEM PRODUCT LINES

A grid of six vacuum pump models, each with a product image, title, description, and a 'CONTINUE READING' button. The pumps are arranged in two columns and three rows. The top row shows the TMSRV630 and TMSRV305 models. The middle row shows two more views of the TMSRV305 model. The bottom row shows the TMSRV255 and TMSRV165 models. The bottom-most row shows the TMSRV100 and TMSRV63 models, with a 'MADE IN USA' logo and an American flag graphic between them.

**TMSRV630 Vacuum Pump**  
TMSRV630 Vacuum Pump with OEM Warranty from TMS CFM 490...  
[CONTINUE READING →](#)

**TMSRV305 Vacuum Pump**  
TMSRV305 Vacuum Pump with OEM Warranty from TMS CFM 194...  
[CONTINUE READING →](#)

**TMSRV255 Vacuum Pump**  
TMSRV255 Vacuum Pump with OEM Warranty from TMS CFM 180...  
[CONTINUE READING →](#)

**TMSRV165 Vacuum Pump**  
TMSRV165 Vacuum Pump with OEM Warranty from TMS CFM 117...  
[CONTINUE READING →](#)

**TMSRV100 Vacuum Pump**  
TMSRV100 Vacuum Pump with OEM Warranty from TMS CFM

**TMSRV63 Vacuum Pump**  
TMSRV63 Vacuum Pump with OEM Warranty from TMS CFM

**MADE IN USA**



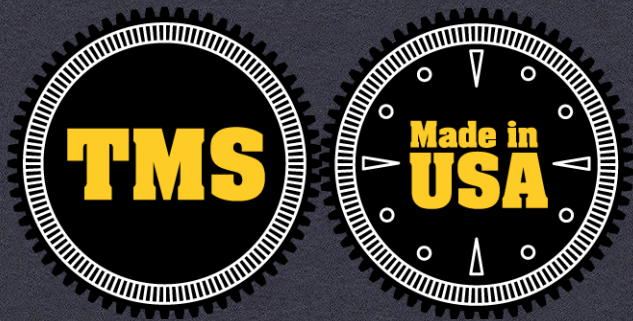

# RECONDITIONED PUMPS & REPAIRS



- STANDARD BASE REPAIR PRICING PER MODEL
- QUOTE EACH REPAIR UPON TEAR DOWN AND INSPECTION
- ONLINE PHOTO GALLERY FROM TEAR DOWN
- 2-3 WEEK TURN AROUND
- REAL TIME PROCESS TRACKING & REPORTING
- EMERGENCY EXCHANGE PROGRAM CAN BE SAME DAY
- ALL PUMPS HOT TESTED AND WARRANTIED
- ON-SITE CNC FOR CYLINDERS



***MOTION***



# EMERGENCY PUMP EXCHANGES **MOTION**

- NO WAIT TIME
- SAME DAY SHIPPING WITH PHOTO OF BROKEN PUMP AND PO BY 2PM CT
- CUSTOMER SENDS BROKEN PUMP TO TMS
- CUSTOMER PAYS FOR COST OF PUMP REPAIR BACK TO OEM STATUS

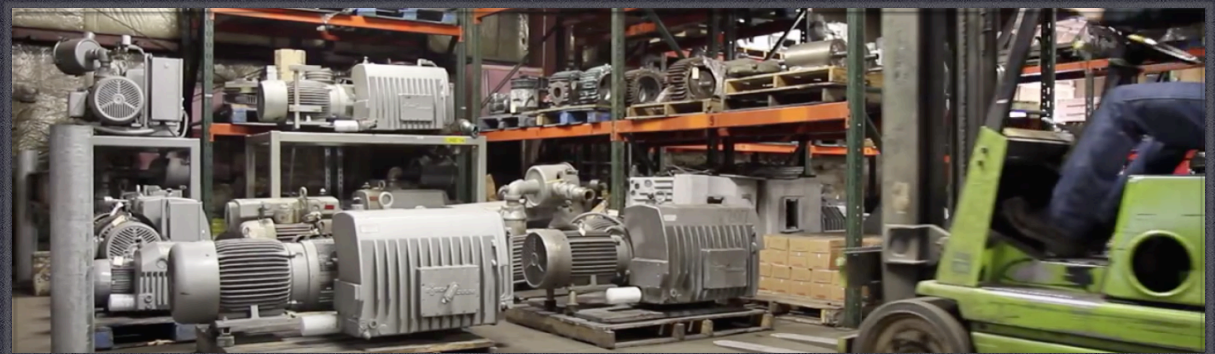

# **iMOTION**

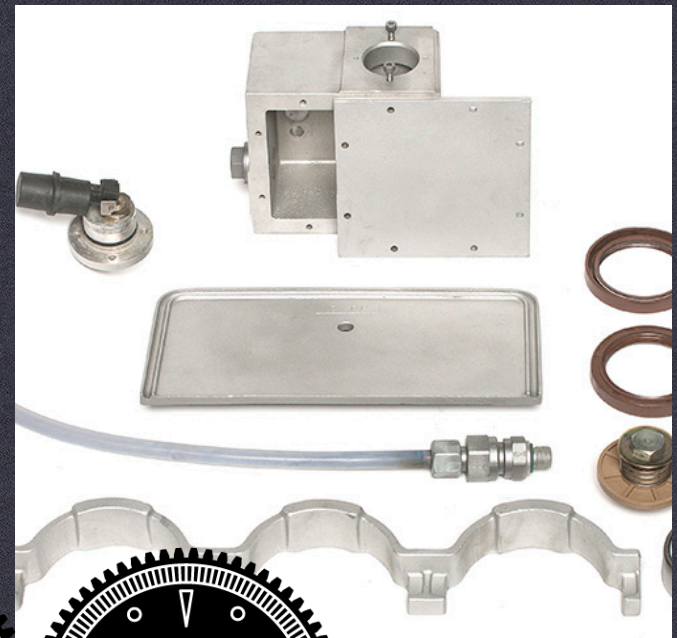
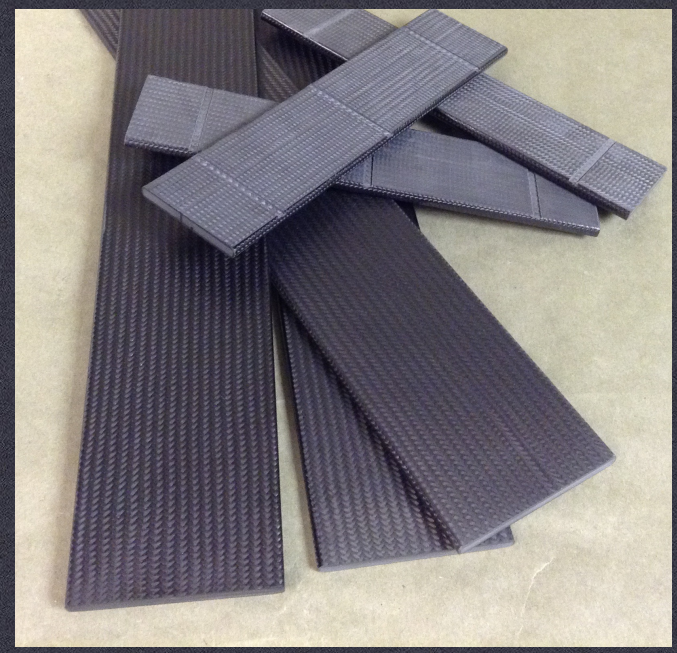

**PARTS, OIL, FILTERS & SUPPLIES**



# ISO 100 - 30WT NON DETERGENT & ISO 100 - 30WT SYNTHETIC FOOD GRADE

- LONG LIFE OIL
- LOW VAPOR PRESSURE
- OUTSTANDING WEAR & CORROSION PROTECTION
- LOW OPERATING TEMP FOOD GRADE
- TOTES
- 55 GALLON
- 5 GALLON



Required for high performing rotary vacuum

### Specifications, Approvals & Recommendations.

ISO 6743-3A-DVC

For a full listing of equipment approvals and recommendations, please consult Technical Data Sheet

| Properties                 | Method             | Vacuum Pump Oil |
|----------------------------|--------------------|-----------------|
| ISO Viscosity Grade        | ISO 3448           | 100             |
| Kinematic Viscosity @40°C  | cSt ASTM D445      | 108             |
| Kinematic Viscosity @100°C | cSt ASTM D445      | 11.8            |
| Density @15°C              | kg/m3 ASTM D1298   | 882             |
| Flash Point COC            | °C ASTM D92        | 265             |
| Pour Point                 | °C ASTM D97        | -9              |
| Neutralisation value       | mg KOH/g ASTM D947 | <0.04           |
| Ash, sulphated             | % DIN 51575        | <0.01           |

TMS VACUUM OIL PRODUCTS





• YES, TMS FILTERS CAN MAKE A DIFFERENCE IN FOR YOUR EQUIPMENT PERFORMANCE

- TMS OIL FILTERS
- TMS EXHAUST FILTERS

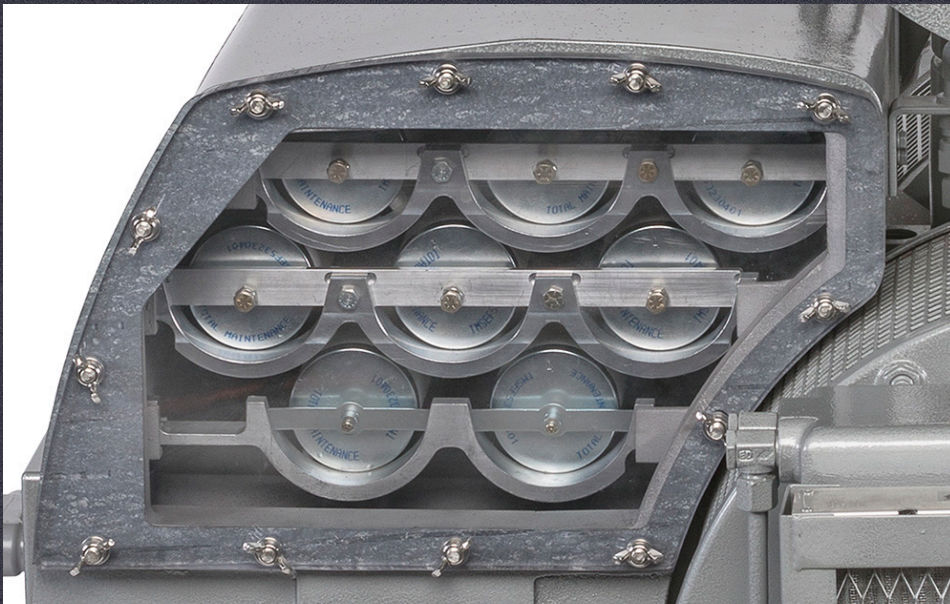

**MOTION**

**TMS VACUUM FILTERS**





# MORE TMS DIFFERENCES

- PICKUP & DELIVERY
- REAL TIME REPAIR TRACKING & REPORTING
- 1 YEAR WARRANTY ON ALL NEW AND REBUILT
- DETAILED REPAIR REQUIREMENT PHOTOS
- TRADE-IN BONE YARD PUMPS
- SAME DAY SHIPPING W PO BY 2PM CT
- ALL PUMPS HOT TESTED TO  $> .5$  TORR
- HOW TO VIDEOS FOR PM & TESTING
- TECHNICAL EXPERTISE AND SUPPORT
- ANNUAL ON-SITE PUMP INSPECTION



***MOTION***